

PICO-IMX7



- The PICO-IMX7 is a System on Module (SOM) based on an NXP i.MX7 Dual core Cortex-A7™ + M4™ processor clocking up to 1GHz.
- The PICO-IMX7 operates in commercial and extended temperature ranges from -20 to 70°C, providing industrial interfaces such as RGMII, USB, I²S, CAN, UART, SPI, I²C, PWM, GPIO with a RGB TTL graphic interface.
- The PICO-IMX7 is a member of the TechNexion “PICO pin-to-pin” product family, targeting low-power consumption embedded applications.
- Accelerate your time-to-market and reduce development costs with TechNexion pre-certified FCC / IC / CE / RCM / TELEC dual-band Wi-Fi 802.11 ac/a/b/g/n, Bluetooth.
- Linux, Yocto, Android runtime images and full source code available.

Specifications



yocto
PROJECT



Core System

Processor	NXP i.MX7 Dual
Processor speed	up to 1GHz
Architecture	ARM Cortex-A7 + M4
PMIC	NXP PF3000
Memory	up to 2GB DDR3L
Storage	eMMC (4GB Default) MicroSD Cardslot (optional)
Board-to-Board Connector	Edison compatible connector PICO 70-pin Hirose connectors
System on Module	PICO System on Module

Connectivity

Network LAN	RGMII
Wi-Fi/Bluetooth	Qualcomm QCA9377 802.11 a/b/g/n/ac + BT (BR+EDR+BLE)
Antenna	MHF4 connector

Signaling

I/O	RGB TTL	SDIO
	MIPI CSI	CAN
	MIPI DSI	UART
	RGMII	SPI
	PCIe	I ² C
	USB	PWM
	USB OTG	GPIO
	I ² S	

Video

Graphic Engine	Image re-sizing / rotation / overlay and CSC Pixel Processing Pipeline
Camera	MIPI CSI (2 lanes)

Audio

Audio Codec	On carrier board
Audio Interface	I ² S (2 channel)

Operation Systems

Standard Support	Linux Yocto Android
------------------	---------------------------

Certification and Compliance

USA	FCC ID: 2AKZA-QCA9377
Canada	IC: 22364-QCA9377
Japan	TELEC: 201-180629
European Union	EN 55032 / EN 55024 EN 300 328 v2.2.2 EN 301 893 v2.1.1
Australia/New Zealand	RCM
Bluetooth Logo	QDID150839 (Bluetooth 4.2)
Certification	Compliant with RoHS / REACH directives

Block Diagram

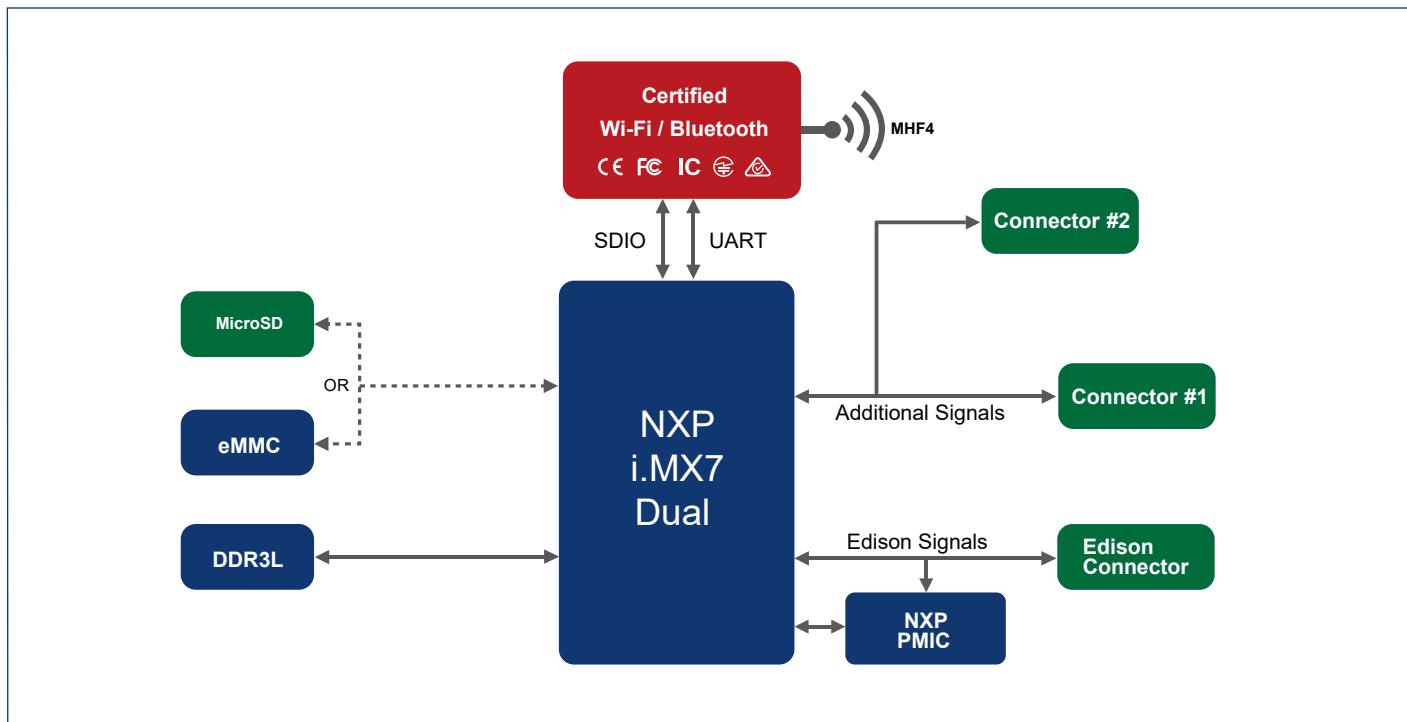

Environmental and Mechanical

Dimensions	37 x 40 mm / 1 3/8 x 1 5/8 inch
Form Factor	PICO Compute Module
Weight	8 grams
Temperature	Commercial: 0° to +60°C Extended: -20° to +70°C
Relative Humidity	10 to 90 %
MTBF	>100 000 Hours
Shock	50G/25ms
Vibration	20G/0-600Hz

Power Specifications

Power Input	4.25-5.25 VDC
Power Consumption	Depending on Configuration

Dimensions

(units in mm)

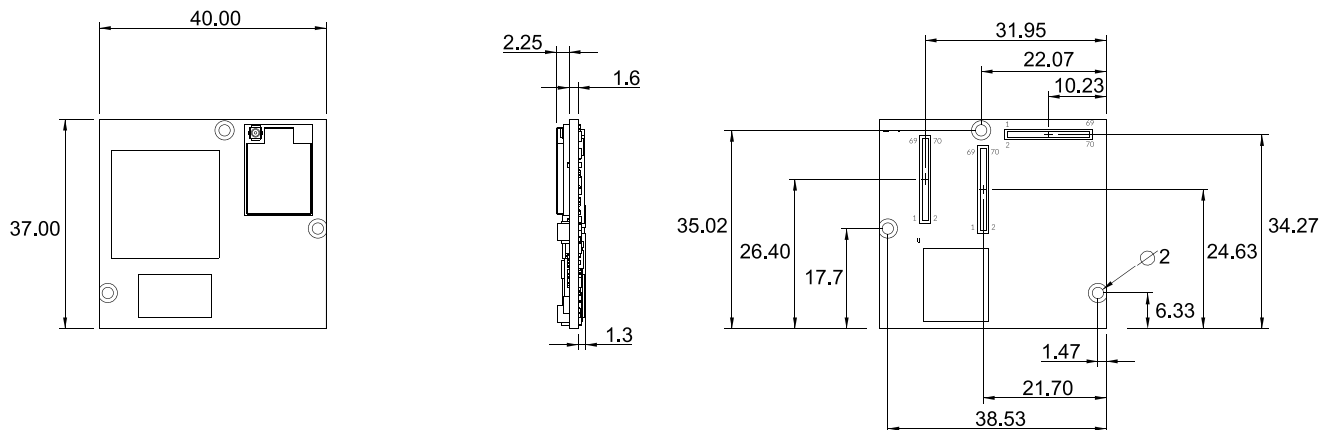

Order Information :

PICO-IMX7x-xx-Rxx-xxx-xxxx-xx-xxxx

	Code	Description
Processor	IMX7D	NXP i.MX7Dual
Processor Speed	08	800MHz
	10	1.0GHz
Memory	R05	512MB DDR3L
	R10	1GB DDR3L
Storage	MSD	MicroSD Cardslot
	E16	eMMC 16GB
	EXX	eMMC other capacity
Wi-Fi / Bluetooth	-	-
Temperature Range	9377	Qualcomm QCA9377 802.11a/b/g/n/ac (2.4 + 5GHz) + Bluetooth
	-	Commercial Temperature range (0° to +60°C)(Default)
	TE	Extended Temperature range (-20° to +70°C)
Custom ID	XXXX	Custom Part number ID for customized software loader and special component (BOM)